

# *Powerlyzer*

**Power Quality Monitor**

## **Operators Guide**

**October 2008**

**Valquest Systems Inc.  
351 S. Sherman, St. # 100  
Richardson, Tx. 75081**



© CopyRight 2004-2009 – Valquest Systems Inc.  
All Rights Reserved

Valquest Systems Inc.  
351 S. Sherman, St.#100  
Richardson, Tx. 75081

This Publication contains proprietary information that is protected by copyright and licensing agreements. No part of this publication may be reproduced, transcribed, stored in a retrieval system, translated to any language or computer language, or transmitted in any form whatsoever without the prior written consent of Valquest Systems Inc.



# Table of Contents

- 1.0 Introduction..... 8**
- 1.1 Powerlyzer Variants ..... 8**
- 2.0 Overview of Features..... 9**
- 2.1 Power Meter ..... 9**
- 2.2 Power Quality Monitor..... 9**
- 2.3 Trend Recorder..... 9**
- 2.4 Manual Operator Controls ..... 10**
- 2.5 Powerlyzer Companion Software..... 10**
- 3.0 Voltage/Current Input Cables & Connections..... 11**
- 3.1 Input Voltage Configurations ..... 11**
- 3.2 Input Connections..... 12**
- 3.2.1 120 VAC/Single Phase (Volts Only) ..... 12**
- 3.2.2 120/240 V Split Phase..... 13**
- 3.2.3 120/208 V 4-Wire Y..... 13**
- 3.2.4 139/240 V 4-Wire Y..... 14**
- 3.2.5 240 V 3-Wire Delta..... 14**
- 3.2.6 240 V 4-Wire Delta..... 16**
- 3.2.7 277/480 V 4-Wire Y..... 16**
- 3.2.8 480 V 3-Wire Delta..... 17**
- 3.2.9 480 V 4-Wire Delta..... 18**
- 3.3 Automatic Voltage/Current Checks..... 19**
- 4.0 Display Menu..... 19**
- 4.1 Menu System Operation..... 19**
- 4.2 Basic Flow Diagram..... 20**
- 4.3 Reading the Voltage Display ..... 21**
- 4.4 Reading the Meter Display..... 21**
- 4.5 Parametrics Menu..... 21**
- 4.6 Setup Menu..... 23**
- 4.7 Setup – (Date & Time)..... 25**
- 4.8 Setup – Elect. Configuration (Voltage)..... 25**
- 4.9 Setup – Elect. Configuration (CT Current Ratio) ..... 27**
- 4.9.1 Current Transducer with mA/A CT Output ..... 27
- 4.9.2 Current Transducer with mV/A CT Output ..... 29
- 4.10 Setup – Elect. Configuration (Current Input Range)..... 31**
- 4.10.1 Current Transducer with mA/A CT Input Range ..... 31
- 4.10.2 Current Transducer with mV/A CT Input Range ..... 32
- 4.11 Setup – Elect. Configuration (Line Frequency) ..... 33**
- 4.12 Setup – Elect. Configuration (V-I Phase Offset)..... 34**
- 4.13 Setup - Unit ID ..... 35**
- 4.14 Record Mode ..... 36**
- 5 Self-Test ..... 38**
- 6 Powerlyzer Features ..... 39**



<b>7</b>	<b>Recording Parameters</b> .....	<b>39</b>
<b>8</b>	<b>Environmental Specifications</b> .....	<b>39</b>
<b>9</b>	<b>Recommended &amp; Optional Accessories</b> .....	<b>40</b>
<b>9.1</b>	<b>AC Current Transformers/Probes (Current Output)</b> .....	<b>40</b>
<b>9.2</b>	<b>AC Current Transformers/Probes (Voltage Output)</b> .....	<b>41</b>
<b>9.3</b>	<b>Mounting Accessories (Optional)</b> .....	<b>42</b>
<b>10</b>	<b>About Valquest Systems</b> .....	<b>44</b>



## Table of Figures

Figure 1	Display & Controls.....	10
Figure 2	AC Line Cord .....	11
Figure 3	Multi-Voltage Cable.....	11
Figure 4	Input Connections.....	11
Figure 5	120/240 V Split Phase .....	13
Figure 6	120/208 V 4-Wire Y.....	13
Figure 7	139/240 V 4-Wire Y.....	14
Figure 8	240 V 3-Wire Delta .....	14
Figure 9	240 V 3-Wire Delta (Alt-1).....	15
Figure 10	240 V 3-Wire Delta (Alt-2).....	15
Figure 11	240 V 4-Wire Delta .....	16
Figure 12	277/480 V 4-Wire Y.....	16
Figure 13	480 V 3-Wire Delta .....	17
Figure 14	480 V 3-Wire Delta (Alt-1).....	17
Figure 15	480 V 3-Wire Delta (Alt-2).....	18
Figure 16	480 V 4-Wire Delta .....	18
Figure 17	Version Display.....	20
Figure 18	Voltage Menu .....	20
Figure 19	Power Menu.....	20
Figure 20	Parametric Menu .....	20
Figure 21	Setup Menu.....	20
Figure 22	Parametrics Menu (Yes).....	22
Figure 23	Parametrics (Phase V-I).....	23
Figure 24	Parametrics (kW,kVAr,kVA).....	23
Figure 25	Parametrics .....	23
Figure 26	Setup (Yes) .....	24
Figure 27	Date Setup/View Display .....	25
Figure 28	Time Setup/View Display .....	25
Figure 29	Voltage Configuration.....	26
Figure 30	Sample CT Ratio Settings .....	28
Figure 31	Sample CT Ratio Settings .....	30
Figure 32	Current Input Range .....	31
Figure 33	Current Input Range .....	32
Figure 34	Line Frequency Settings .....	33
Figure 35	V-I Phase Offset Settings .....	34
Figure 36	Unit ID Setting .....	35
Figure 37	Voltage/Meter Displays.....	37
Figure 38	Record Mode Off.....	37
Figure 39	Erase Data (No).....	37
Figure 40	Erase Data (Yes).....	37
Figure 41	Record Mode (On).....	37
Figure 42	Self Test Menu .....	38
Figure 43	Self Test Version .....	38



Figure 44 Self Test Result..... 38  
Figure 45 Self Test - Bit Status..... 38  
Figure 46 Pole Mounting Kit ..... 42  
Figure 47 Powerlyzer w/ Pole Mounting Plate ..... 42  
Figure 48 Magnetic Mounting Kit ..... 43  
Figure 49 Powerlyzer w/ Magnetic Mounting Kit..... 43  
Figure 50 Wall Mounting Kit ..... 43  
Figure 51 Powerlyzer w/ Wall Mounting Kit ..... 43



## Safety Considerations

It is recommended that this product and related documentation be reviewed for familiarization with safety markings and instructions before operation.

### Before Applying Power

Verify that the product shows no signs of physical damage that may impair proper operation.

Verify that the Cables & Accessories (Voltage probes/Current Transformers) to be used are in good working condition and that they do not impose any safety hazard such as exposure to electrical shock.

## Warnings



**When OPERATING or CONNECTING the Powerlyzer to a VOLTAGE/CURRENT Source:**

- **Always Wear Protective Goggles or Safety Glasses**
- **Always wear Industrial Grade Electrically Insulated Gloves**
- **NEVER CONNECT the Powerlyzer to Service with a Maximum Nominal Voltage of 480 Volts Phase-to-Phase**
- **NEVER CONNECT any Current Clamps/Probes/other accessories to the Current Inputs that will produce more than 1000 milliAmps RMS (1 Amp RMS Max)**
- **NEVER CONNECT Voltmeter Probes or Test Leads to the Powerlyzer Current Inputs**
- **NEVER CONNECT the Neutral (White) voltage lead to an UNGROUNDED Phase unless the service is an UNGROUNDED 3-WIRE DELTA**



## 1.0 Introduction

The Powerlyzer is a Recording Test Meter based upon the architecture of the Motorola 68HCxx micro-controller. It is used to measure and compute various AC signal characteristics and/or derivative AC signal components. Signal characteristics such as Voltage Blink, Voltage/Current Level, Power Usage, Harmonic Analysis are just a few of the measurements within its capabilities. The Powerlyzer is a small, rugged and lightweight instrument; making trans- portability easy for use in temporary installations where short term or periodic monitoring is necessary. The primary intended use for the Powerlyzer is within the residential and industrial voltage range of 120 VAC to 480 VAC. Front Panel operational controls and accessible connector interfaces make the Powerlyzer simple to setup and operate.

The Powerlyzer is compatible with a wide selection of Voltage and Current Clamps allowing it to function in a diverse set of operating environments. These capabilities along with its feature rich and friendly operating environment make the Powerlyzer a versatile and economical instrument used to measure, record and analyze various power systems and their associated characteristics.

With an optional personal computer or laptop having a Microsoft™ Windows 2000, XP, or later based operating system and the Powerlyzer companion software, users can exchange data between the computer and the Powerlyzers internal memory for configuration, setup or data recording and analysis. The companion software is written using Microsoft Visual Basic™ and features the same look and feel of other windows based visual menu driven environments. The companion software also provides the user with the ability to visually examine the signal characteristics using tables, charts and graphs presenting the information needed to understand and make recommendations for corrective action and improved system performance.

## 1.1 Powerlyzer Variants



*The Powerlyzer is supplied to clients in 2 unique configurations based upon the type of Current Transformer (CT) input. One configuration supports CT's which provide a current output (mA/A), the other supports CT's which provide a voltage output (mV/A). To Verify the particular input type, refer to the unit labels and/or refer to the Version number within the Powerlyzer.*

*CT Current Output Mode – Version 3.3.x*

*CT Voltage Output Mode – Version 3.3.y*

*(where x is even digit and y is odd digit)*





## 2.0 Overview of Features

### 2.1 Power Meter

Using internal and proprietary algorithms the Powerlyzer is able to sample, capture and record the input signal waveforms for both voltage and current over a given time interval. The system displays the following parameters:

#### Parameters for 1,2 or 3 Phase Circuits

Voltage	Current
kW and kWh	kVAr and kVArH
kVA	Phase Angle
Power Factor	Line Frequency
Phase Rotation	

### 2.2 Power Quality Monitor

The user has the ability to set and control the Powerlyzer to Record input signal data. This data is written/stored in the internal memory of the Powerlyzer eliminating the need for external storage or recording devices. Some of the Types of Data that are recorded are as follows:

- Blinks
- Brown-outs
- 3 Types of Min-Max Information
- Capture Voltage/Current Waveforms
- Calculates Harmonics (to the 63<sup>rd</sup>)

### 2.3 Trend Recorder



*A computer having an RS-232 connection is required to setup the trend recorder parameters. (Refer to the Software Companion Guide for details)*

*No Computer is required to manually Start and Stop the Trend Recorder.*

The user has the ability to setup and control the time interval of the measurement values shown below. The interval periods are as follows:



Interval (In Minutes)  
1  
2  
5  
15

## 2.4 Manual Operator Controls

Controlling the Powerlyzer is simple and easy using the display driven menu system. When power is applied to the unit, the 16 character x 2 line lcd display panel will provide information to the user. There are 2 user input controls which allow the user to manually communicate with the unit. These controls consist of a rotating switch and a momentary pushbutton switch. By using these 2 controls the user can follow the pre-programmed menu system and select the appropriate choices for the type of application or setup condition needed.



Figure 1 Display & Controls

## 2.5 Powerlyzer Companion Software

The companion software provides an extensive set of features and tools that make operator examination of signal characteristics, trend recordings and signal data analysis easy and convenient. Refer to the attached Powerlyzer Companion Software Users Guide for detailed information.



### 3.0 Voltage/Current Input Cables & Connections

The Powerlyzer is shipped with 2 voltage cables. One cable is for connecting the unit to a standard 120/60Hz ac outlet. The second cable features a set of Class III 1000v/20A alligator style clamps at one end to allow the user to connect the unit to a multitude of operating environments. Cables connections to the unit utilize a 7-pin circular connector for ease of interchangeability. Current Transformers are connected using standard Banana Plugs to the Banana jacks located on the bottom of the Powerlyzer.



Figure 2 AC Line Cord



Figure 3 Multi-Voltage Cable

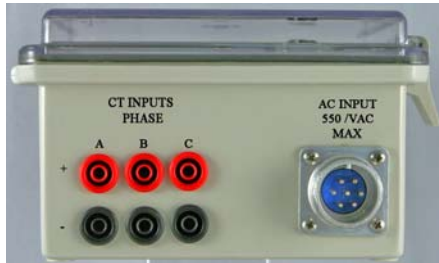

Figure 4 Input Connections

### 3.1 Input Voltage Configurations

Along with the many other features, the Powerlyzer requires no additional power connections or special supplies. The design allows it to work readily with most common lower AC voltage ranges. Power for the unit is supplied by the phase A voltage input line so external power sources are eliminated. The voltage configurations currently supported are as follows:

- |                     |                  |
|---------------------|------------------|
| 120 V Single Phase  | 240 4-Wire Delta |
| 120/240 Split Phase | 277/480 4-Wire Y |
| 120/208 4-Wire Y    | 480 3-Wire Delta |
| 139/240 4-Wire Y    | 480 4-Wire Delta |
| 240 3-Wire Delta    |                  |



### 3.2 Input Connections



*If you have not read the Warnings and safety information found on Page 7 please do so before continuing!!!*

When using the multi-phase power cable, use Standard Connection chart for each voltage lead to in order make quick and easy identification of each conductor phase. This will ensure proper connections to your power service.

#### Standard Connection Chart

Black Conductor	Phase A
Red Conductor	Phase B
Blue Conductor	Phase C
White Conductor	Neutral



#### NOTE

To:  
Operator  
From:  
Valquest

*When using the current probes it will be necessary to make sure that correct polarity is observed for proper operation!!! If the readings are negative, it will be necessary to reverse the CT on the conductor to obtain the correct polarity resulting in valid measurement data!!!*

#### 3.2.1 120 VAC/Single Phase (Volts Only)

Connect the 120 VAC wall plug cord to the 7 pin circular connector on the bottom right of the Powerlyzer.  
Plug the cord into a wall socket.



### 3.2.2 120/240 V Split Phase

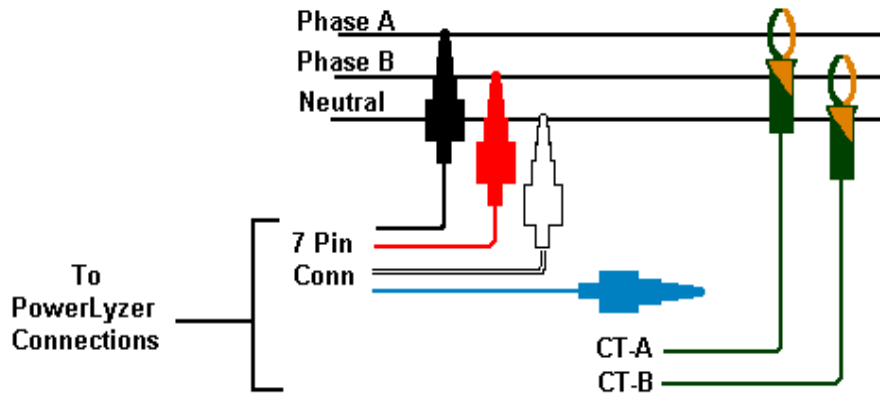

Figure 5 120/240 V Split Phase

### 3.2.3 120/208 V 4-Wire Y

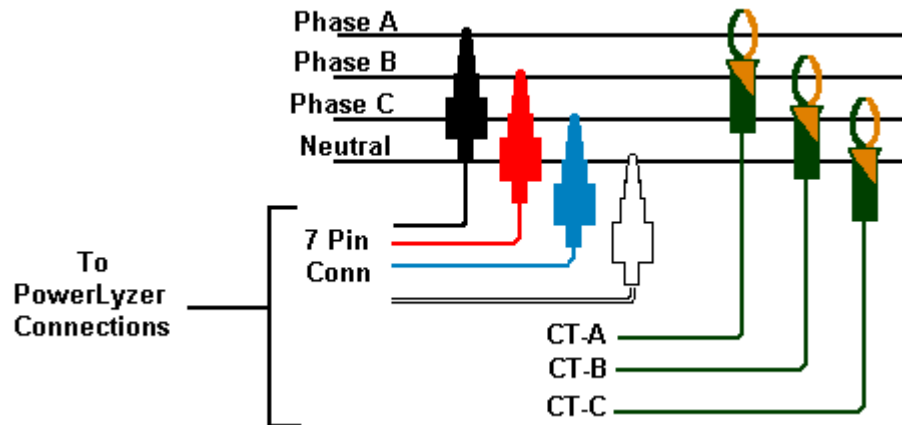

Figure 6 120/208 V 4-Wire Y



### 3.2.4 139/240 V 4-Wire Y

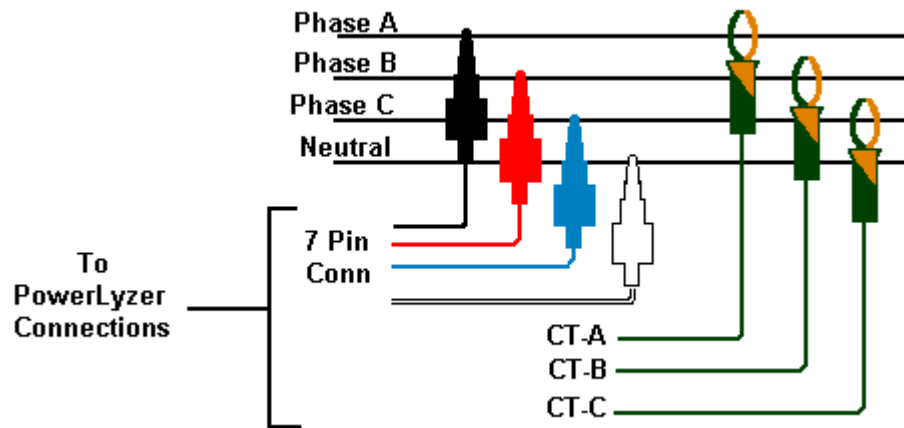

Figure 7 139/240 V 4-Wire Y

### 3.2.5 240 V 3-Wire Delta

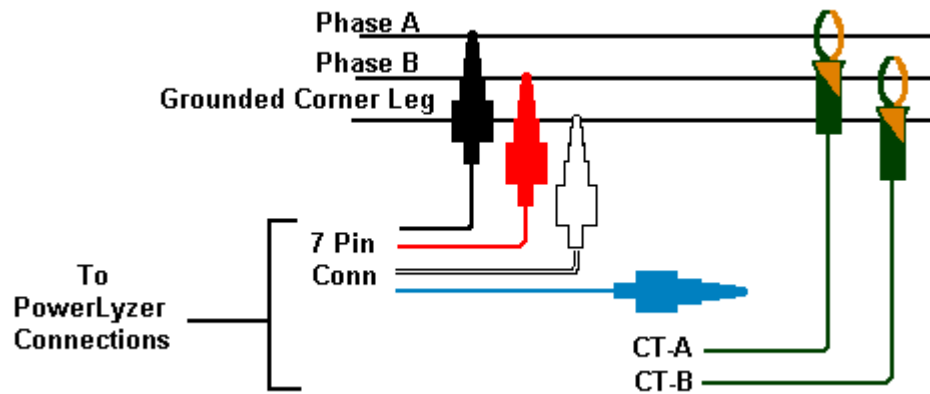

Figure 8 240 V 3-Wire Delta



**Alternate Connections:**

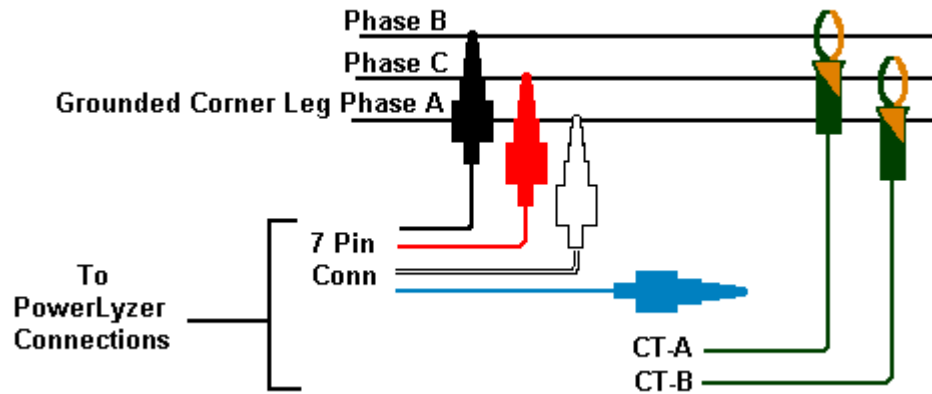

Figure 9 240 V 3-Wire Delta (Alt-1)

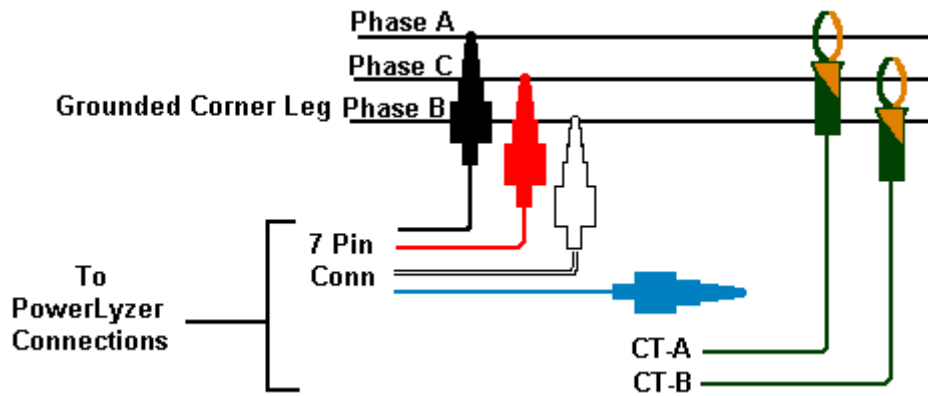

Figure 10 240 V 3-Wire Delta (Alt-2)



### 3.2.6 240 V 4-Wire Delta

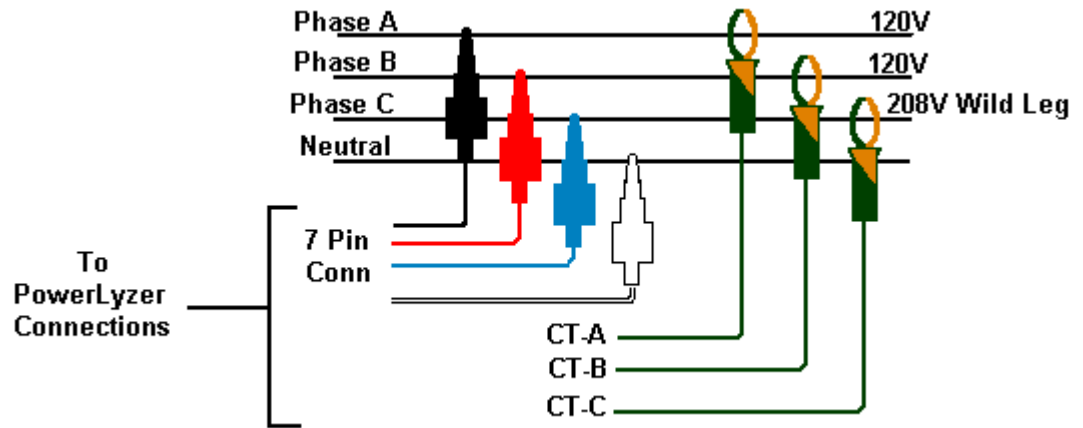

Figure 11 240 V 4-Wire Delta

### 3.2.7 277/480 V 4-Wire Y

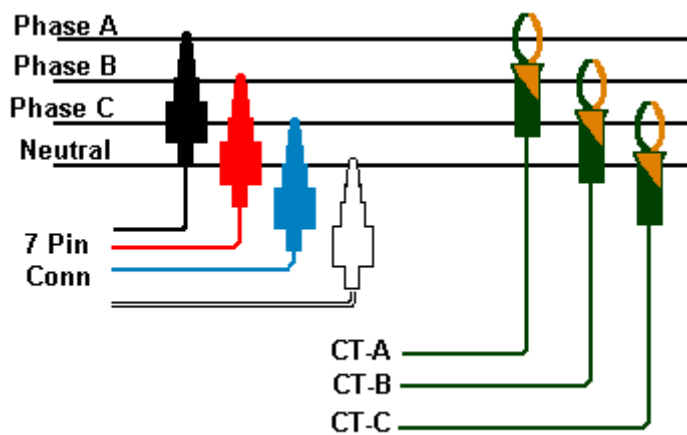

Figure 12 277/480 V 4-Wire Y





### 3.2.8 480 V 3-Wire Delta

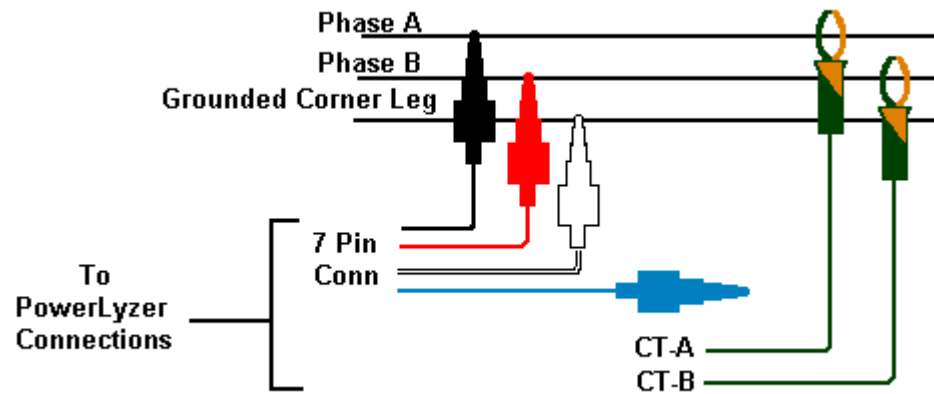

Figure 13 480 V 3-Wire Delta

#### Alternate Connections:

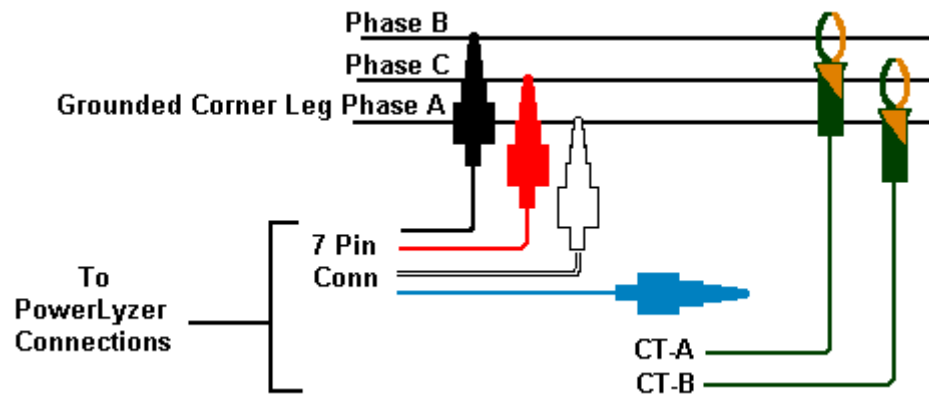

Figure 14 480 V 3-Wire Delta (Alt-1)

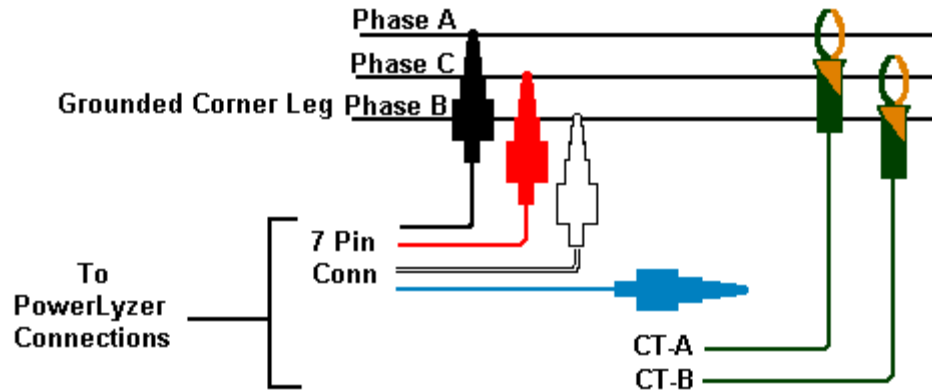

Figure 15 480 V 3-Wire Delta (Alt-2)

### 3.2.9 480 V 4-Wire Delta

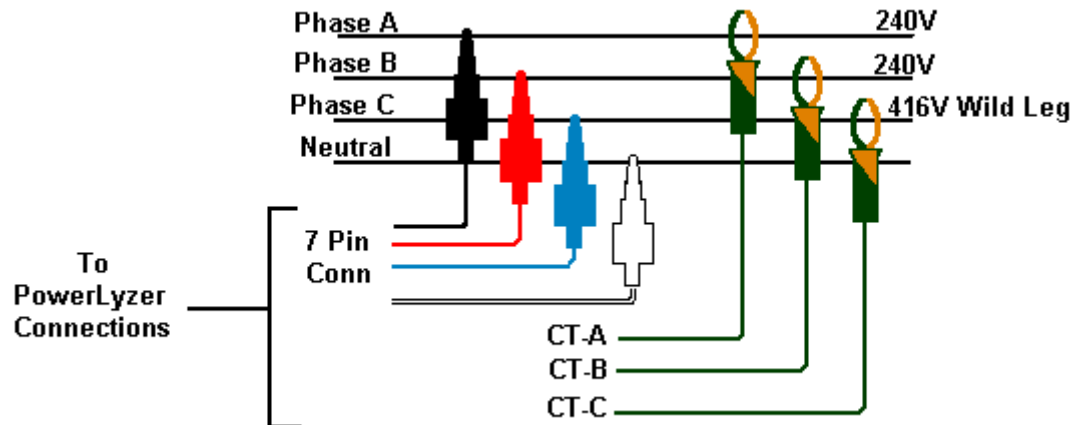

Figure 16 480 V 4-Wire Delta

**Note:** The Powerlyzer treats a 3-wire delta service as a 2-phase (separated by 60 degrees) system with a Neutral. The current readings are adjusted by +/- 30 degrees to compensate for the fact that the voltages are not in phase with the currents. The Powerlyzer automatically detects the phase rotation to determine which phase to add 30 degrees to and from which to subtract 30 degrees.



### 3.3 Automatic Voltage/Current Checks



*The Powerlyzer automatically checks for voltages and currents that exceed measurable limits causing waveform clipping. If waveform clipping is detected, a ^ symbol will appear after the word **Meter** ^ in the Meter display. If this appears check the Parametric values to determine the source of the problem. The two possibilities will be that the **Configuration** is incorrect or the **Current Input Range** is set too low.*

*The Powerlyzer checks for consistent alignment of current clamps. If all phases do not show the same power flow direction, a ? symbol will appear after the word **Meter** ? in the Meter display. If this symbol appears check that all current clamps are oriented in the same direction relative to the load. Adjust clamps as required.*

## 4.0 Display Menu

### 4.1 Menu System Operation

The 16x2 LCD display on the front panel provides the operator with the information about the options, selections and data for the instrument. The information is contained within a pre-programmed menu system making the setup and configuration quick, easy and consistent. The operator moves through the menu system via two controls; a rotating switch (Modify) which provides the paths and selections through the menu, and momentary switch (Enter) which by pressing will select or confirm the choice selected by the operator. This information is then passed to the microcontroller and the appropriate actions are taken in response to the operators commands.



## 4.2 Basic Flow Diagram

The following illustration provides a high level look at the basic menu flow. Each of the menu processes will be discussed in greater detail in the following paragraphs.

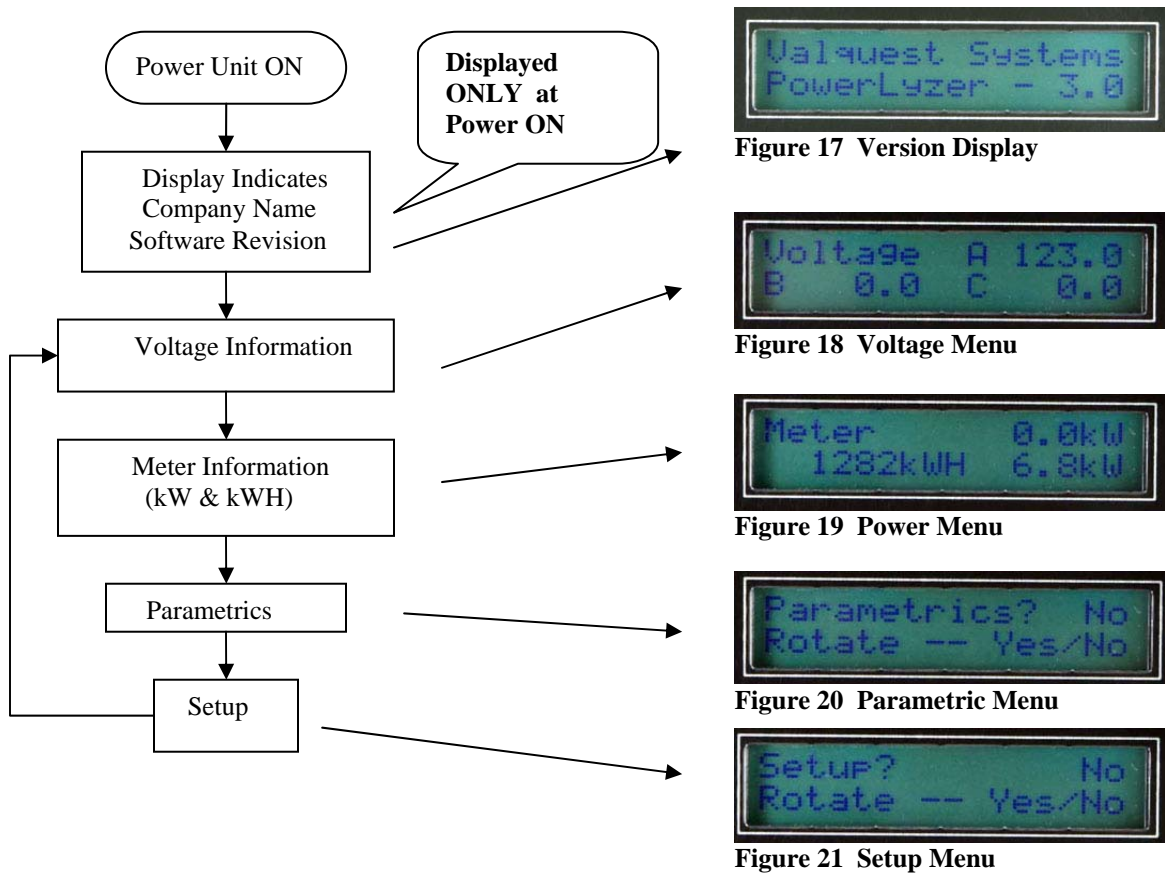



### 4.3 Reading the Voltage Display

The voltage display is used to display the all of the voltages currently being measured. This is based upon the setup configuration. If a single phase is monitored, only that phase will be displayed. If multiple phases are being monitored, each of the multiple phases will be displayed.

### 4.4 Reading the Meter Display

The Meter display is used to display the kW parameters. Refer to to the following illustration for an explanation of the display readout.



*The consumption and demand values are zeroed when the unit is placed into the Record Mode.*

### 4.5 Parametrics Menu

The Parametrics menu to provides the user with detailed information specific to each phase being tested. The information obtained from the Parametrics menu is as follows:

- |                            |                               |
|----------------------------|-------------------------------|
| Line Voltage (each Phase)  | Phase Angle (each Phase)      |
| Line Current (each Phase)  | 3 Phase Rotation (ABC or CBA) |
| kW, kVAr, kVa (each Phase) | Neutral Current               |
| Power Factor (P-Ftr)       |                               |

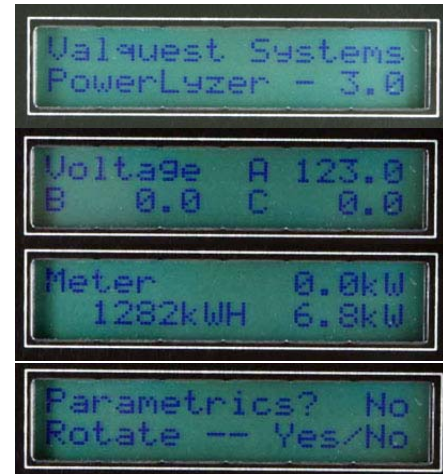
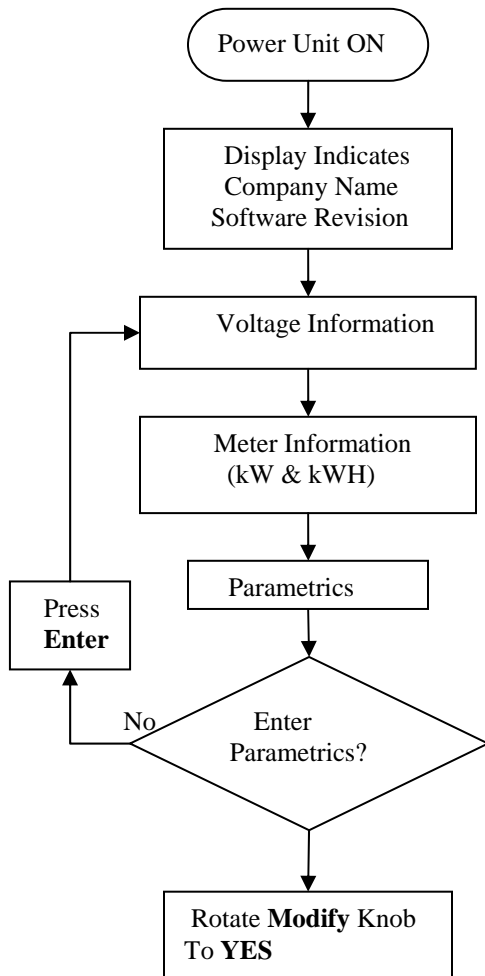

Figure 22 Parametrics Menu (Yes)



### Parametrics Menu (Continued)

The parametric information below displays Phase A information base upon the current setup. When the setup condition specifies more than a single phase the additional phase information will also be present in sub-sequent displays as well as the composite information.

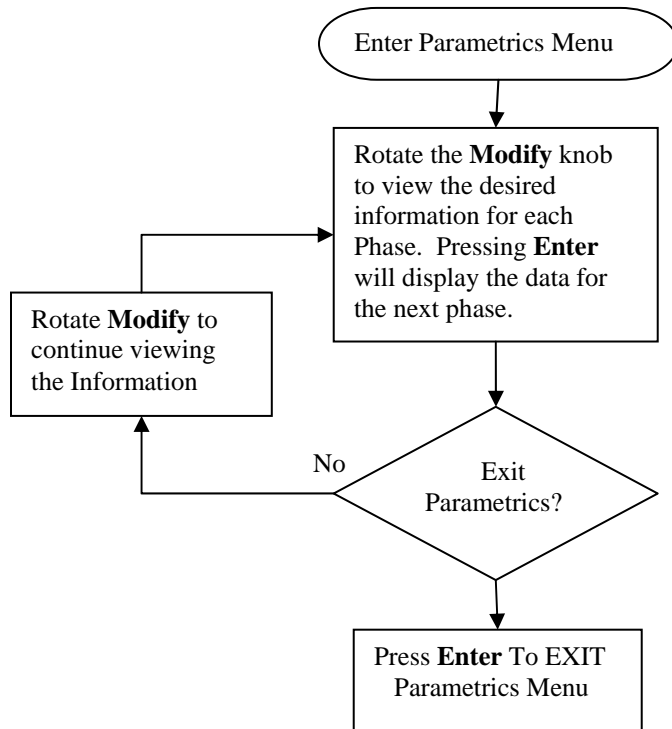

Figure 23 Parametrics (Phase V-I)



Figure 24 Parametrics (kW,kVAr,kVA)



Figure 25 Parametrics (Power Factor, Phase Angle)

### 4.6 Setup Menu

The Setup menu provides the user a means in which to configure the Powerlyzer for a specific test and measurement configuration. This must be performed properly for the test data to have accurate and meaningful information. The Powerlyzer Setup menu provides the user with the option of changing or selecting the following parameters:

- Date
- Time (24 Hr Military Format)
- Voltage Selection
- CT Input Ratio

- Current Input Range
- Line Frequency
- Voltage-Current Offset Values
- Unit ID



**NOTE**  
**To:**  
**Operator**  
**From:**  
**Valquest**

There are 2 methods which may be used to enter the **SETUP** menu.

The first method is to follow the selected menu paths on the display until the **SETUP** menu is presented. Rotate the **MODIFY** knob to obtain a **YES** indication and press the **ENTER** switch.

The second and more direct method is to **PRESS & HOLD** the **ENTER** key for a minimum of 2 seconds.

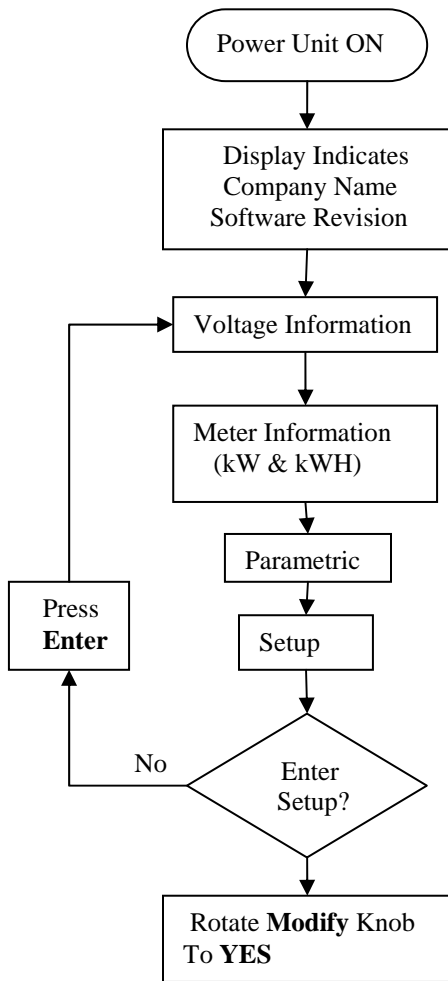

Figure 26 Setup (Yes)





### 4.7 Setup – (Date & Time)

Time displayed in Military Time (24 Hour)

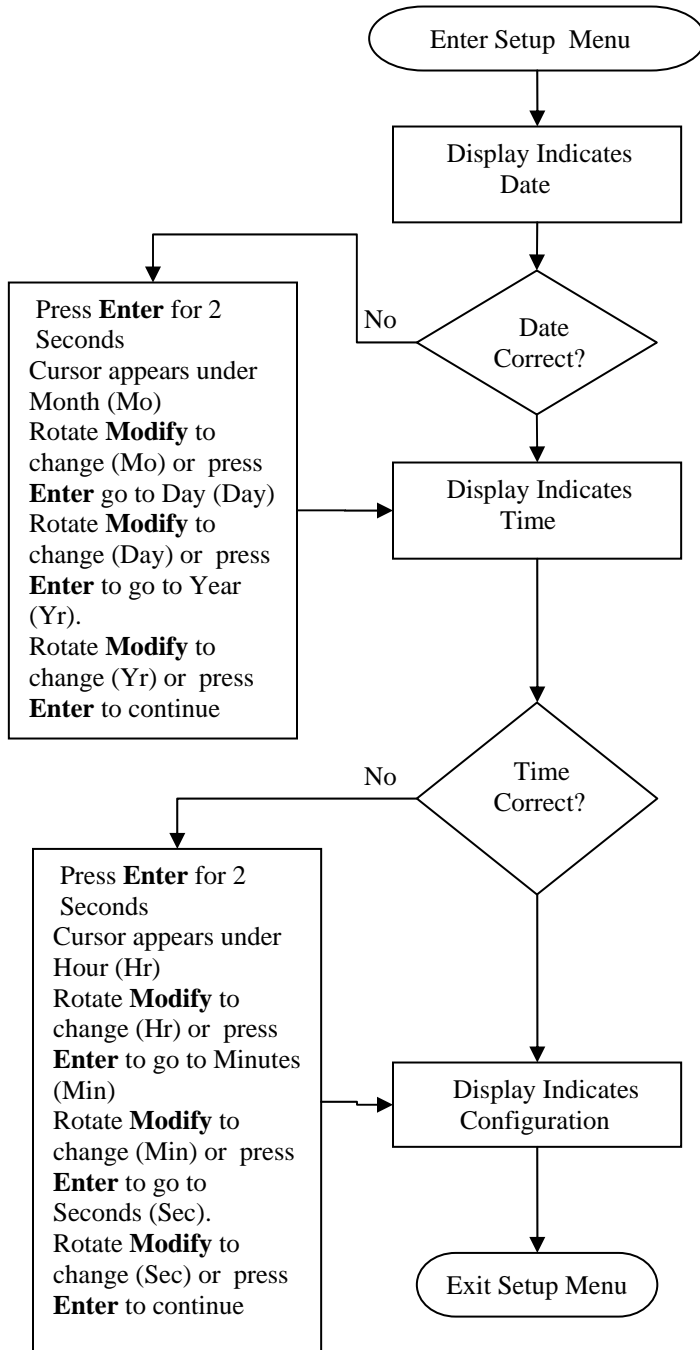

Figure 27 Date Setup/View Display



Figure 28 Time Setup/View Display

**NOTE**  
 To: Operator  
 From: Valquest

*The Date & Time are used for accurate Trend Recording and should be set before starting a Recording Session if they are found to be incorrect!!!*

### 4.8 Setup – Elect. Configuration (Voltage)



The electrical configuration settings describe the type of service that the Powerlyzer will be monitoring. The following illustration provides setup instructions.

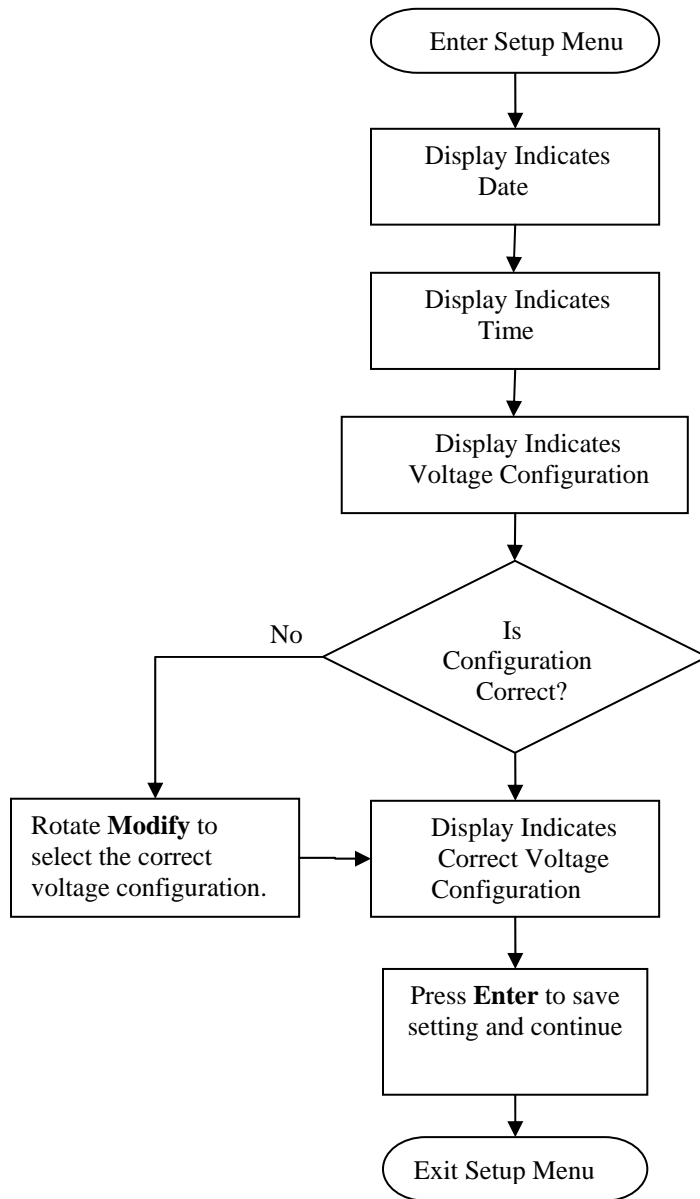

Figure 29 Voltage Configuration Settings



## 4.9 Setup – Elect. Configuration (CT Current Ratio)

As discussed before the Powerlyzer is sold in two variants for different types of Current Transducer (CT) outputs. These types either provide an output having a mA/A output signal or a mV/A output signal. Please refer to the appropriate section below for your particular Powerlyzer model.

### 4.9.1 Current Transducer with mA/A CT Output



The **CT Current Ratio** is normally the CT Ratio of the amp probe being used. A typical value is 1000 or 1000:1. However, when monitoring the second-ary of a large CT, this number is the arithmetic product of the CT ratio and the current ratio of the amp probe.

Example: If you have a 1000:1 amp probe and are monitoring the secondary of an 800:5 CT, the Effective Current Ratio would be  $1000 \times 160 = 160,000$ . You would most likely use 0-5 mA or 0-10mA Input Current Range.

The **Input Current Range** must be set such that the secondary current of the CTs does not exceed the range. A lower range improves resolution. If the range is too low, the current waveform will be clipped.

Example: You are directly monitoring a system that is running about 160 amps. If you are using 1000:1 current clamps you would most likely use the 0-250 mA setting since the current into the Powerlyzer will be about 160 mA.

If you don't know the current, set the Input Current Range to 0-1000 mA. Read the current, the go back and set the Input Current Range to a reasonable value.

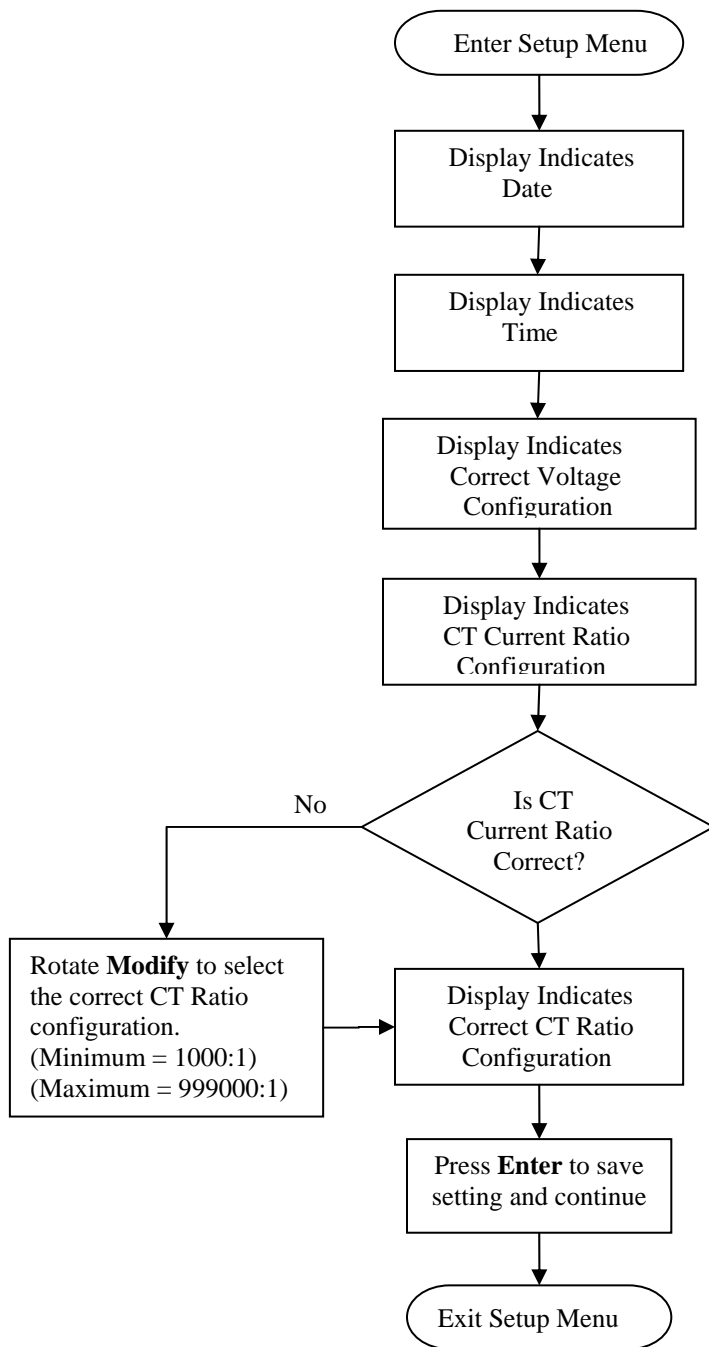



Figure 30 Sample CT Ratio Settings



## 4.9.2 Current Transducer with mV/A CT Output

 <p><b>NOTE</b> <b>To:</b> <b>Operator</b> <b>From:</b> <b>Valquest</b></p>	<p>The CT Current Ratio on CT's having a mV/A output will require the user to set the CT Ratio based upon there specific type of CT.</p> <p>Many of the Rope CTs having an adjustable range switch will require the Powerlyzer to have a 1:1 CT Ratio to obtain accurate readings. If your CT is a single output range with a mV/A then the Powerlyzer should be set to a ratio of 1000:1 for accurate readings.</p>
--	--

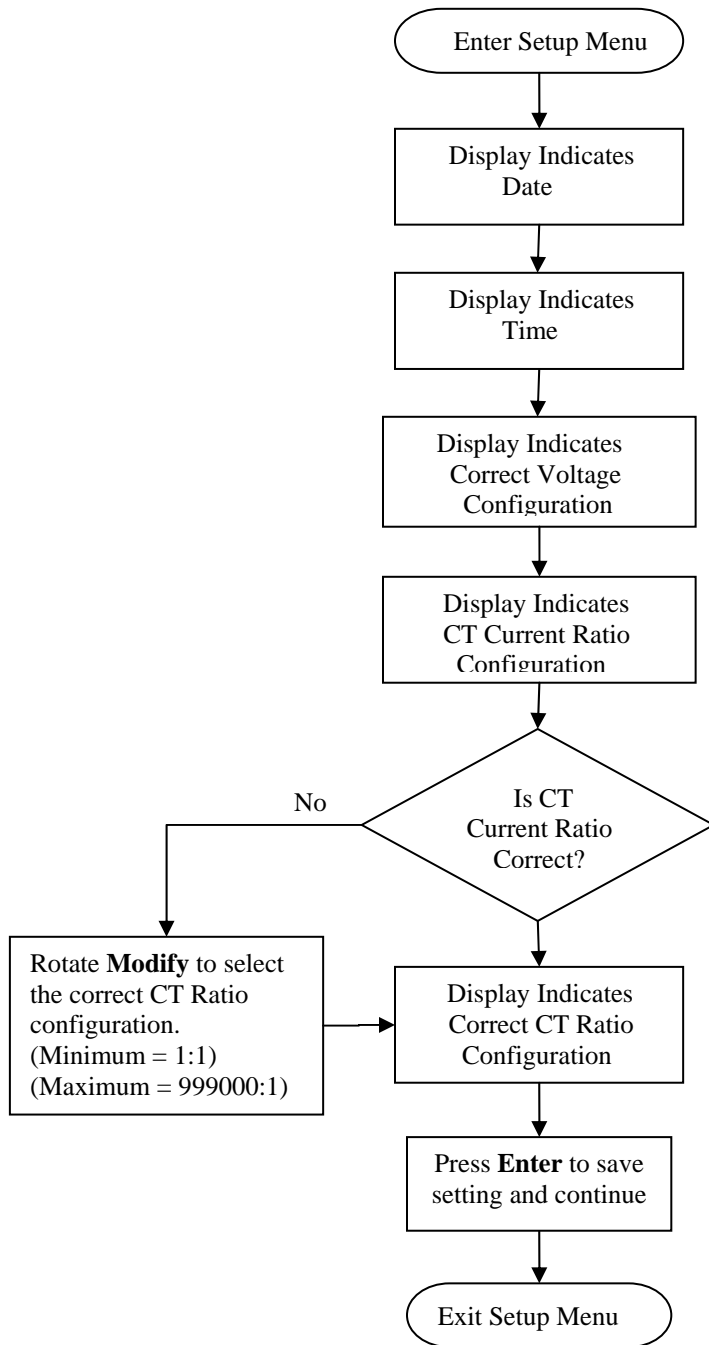

Figure 31 Sample CT Ratio Settings



## 4.10 Setup – Elect. Configuration (Current Input Range)

Refer to the appropriate section below for specific input range setup conditions for your particular Powerlyzer model.

### 4.10.1 Current Transducer with mA/A CT Input Range

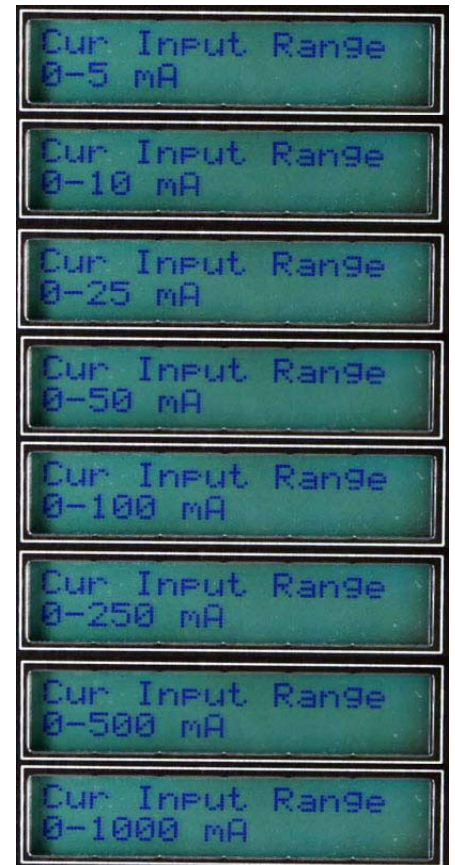
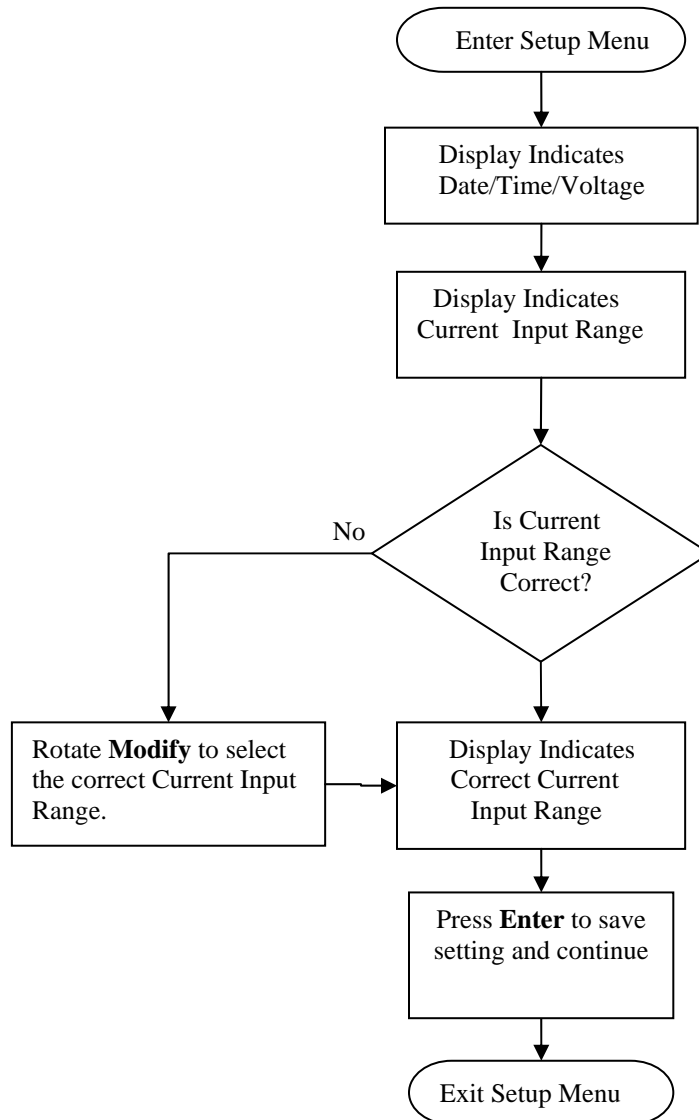

Figure 32 Current Input Range Settings





### 4.10.2 Current Transducer with mV/A CT Input Range

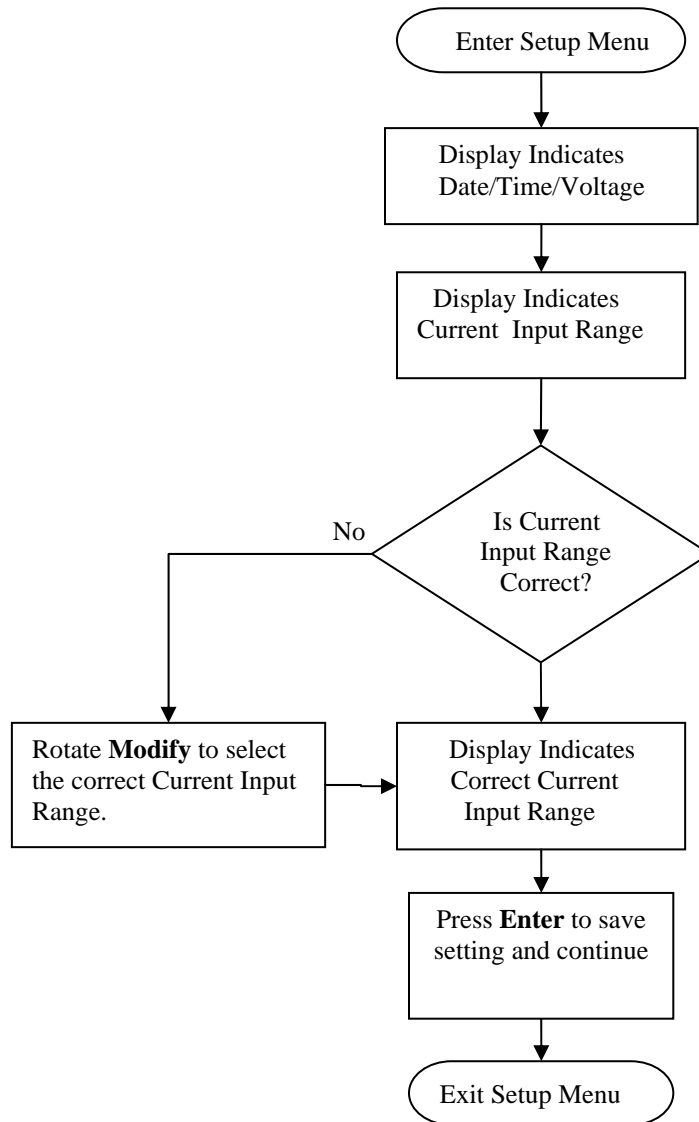

Figure 33 Current Input Range Settings





### 4.11 Setup – Elect. Configuration (Line Frequency)

The line frequency can be set for either 50 or 60 Hz. Most US electrical circuits use 60 Hz.

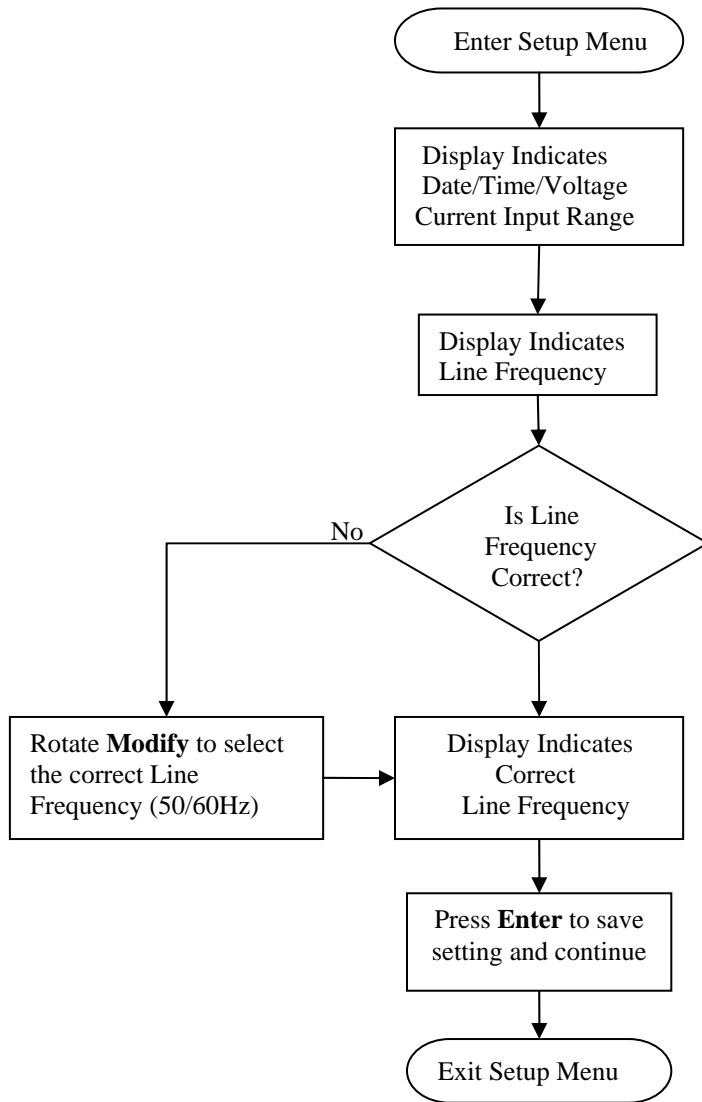

Figure 34 Line Frequency Settings



### 4.12 Setup – Elect. Configuration (V-I Phase Offset)

The Voltage-Current (I) offset can be adjusted from 0° - 359° either positive or negative.

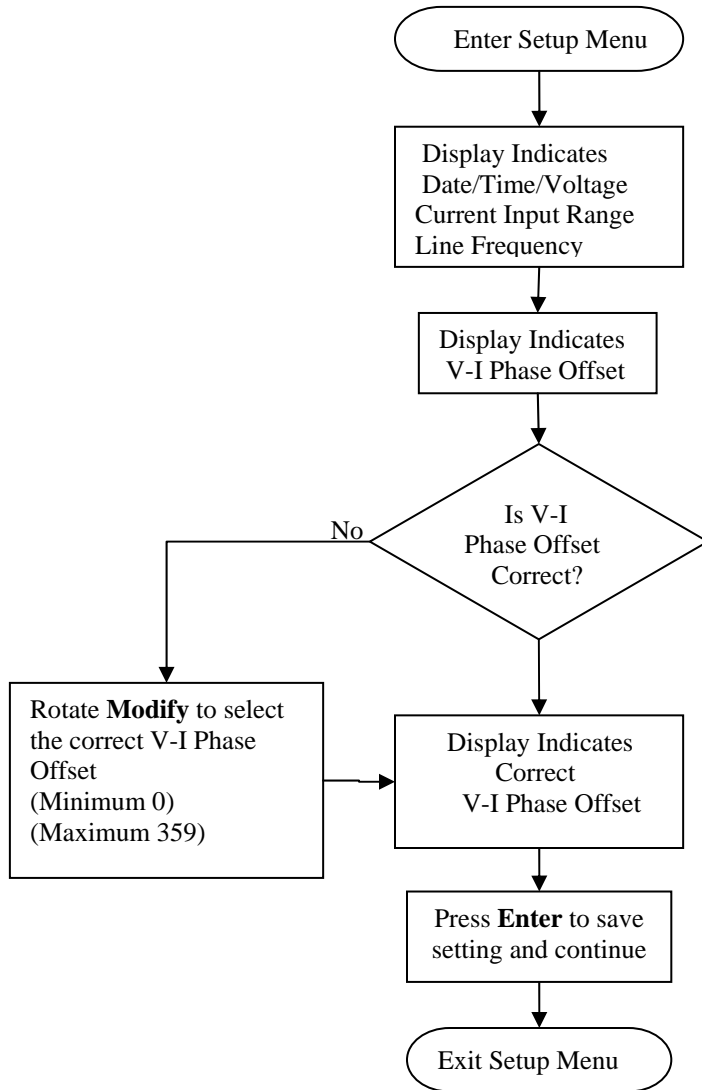

Figure 35 V-I Phase Offset Settings



### 4.13 Setup - Unit ID

The Unit ID provides a specific identifier to each Powerlyzer. This is beneficial when more than one Powerlyzer is available for use in a system.

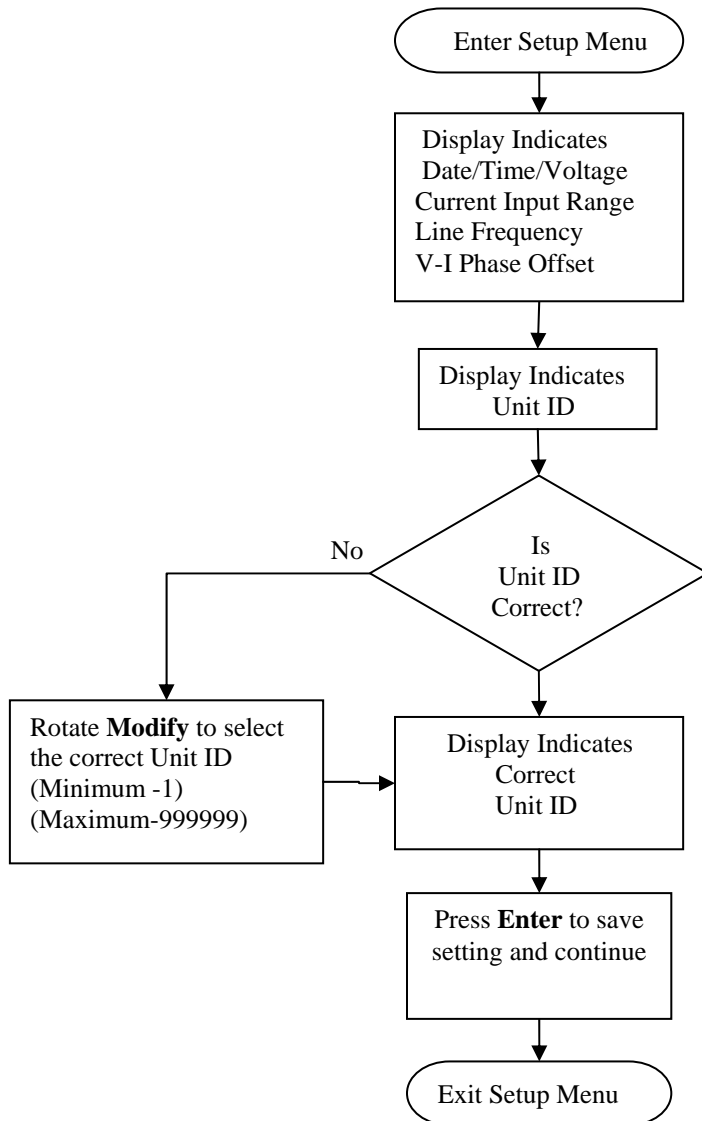

Figure 36 Unit ID Setting



## 4.14 Record Mode

Record mode is used to record the measured electrical Trend data taken by the Powerlyzer and then stores this data in the Powerlyzers internal memory. The nature and amount of data depends upon the Recording Parameters set within the Powerlyzer Companion Software. This data can be downloaded and analyzed using the Powerlyzer Companion Software. This manual will only deal with setting up the Powerlyzer to start/stop data recording, refer to the Powerlyzer Companion Software for details on configuring the Recording parameters as well as downloading the Trend data and performing analysis. The user can enter Recording mode from the Voltage and/or Metering Display menus.



**NOTE**

To:  
Operator  
From:  
Valquest

*All Trend Data, Blink Data and Min/Max Data is erased when the Record mode is entered. Make sure that the data has been downloaded prior to initializing the Record Mode Session or the current data will be Lost!!!*

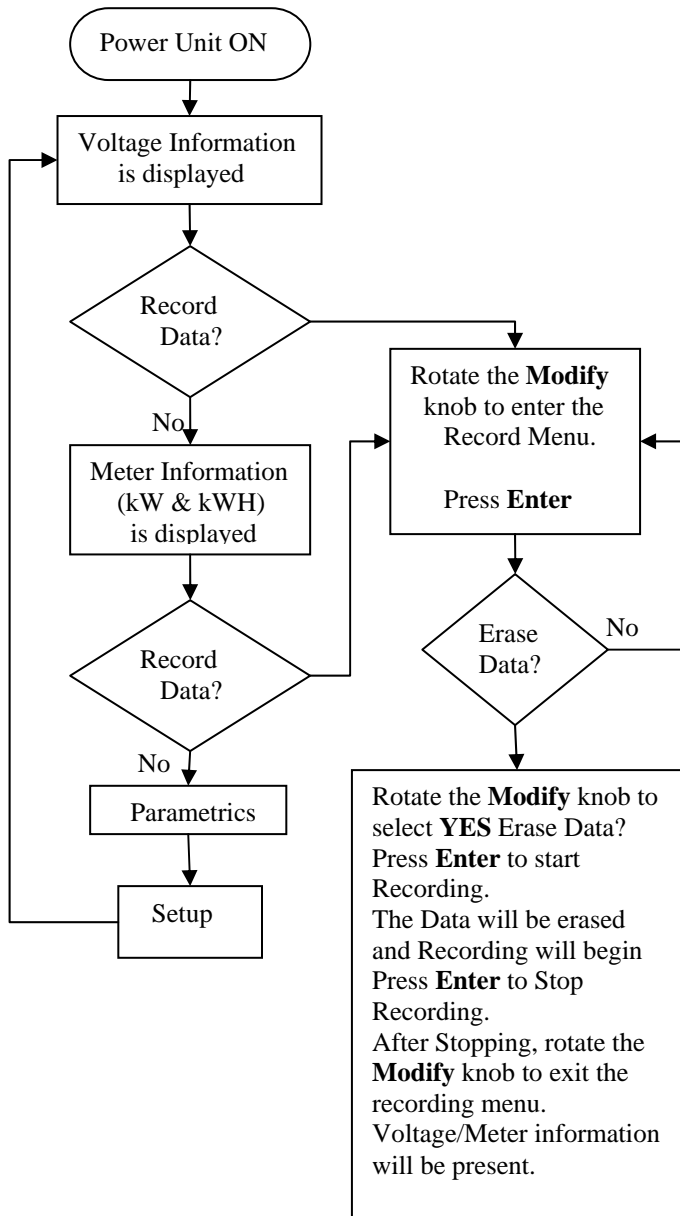

Figure 37 Voltage/Meter Displays

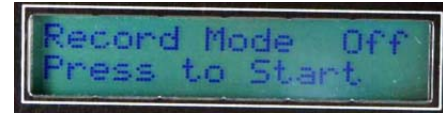

Figure 38 Record Mode Off



Figure 39 Erase Data (No)



Figure 40 Erase Data (Yes)



Figure 41 Record Mode (On)



## 5 Self-Test

The Powerlyzer has a built-in Self-Test operation to verify and check the internal functionality of the unit.

**NOTE**  
**To:**  
**Operator**  
**From:**  
**Valquest**

*This routine **does not need** to be performed for normal setup and use. It is intended to be used only when a suspected malfunction of the unit has occurred or as necessary to verify that the unit is still functioning correctly.*

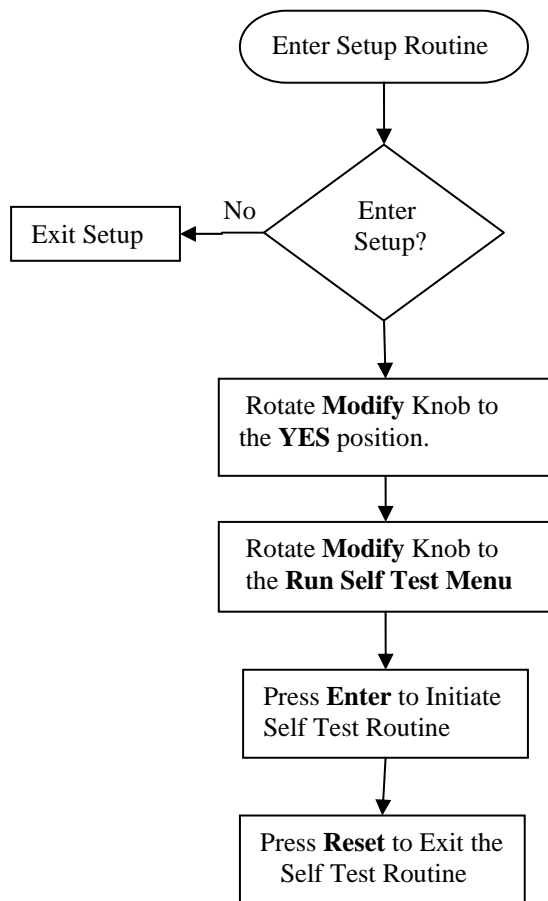

Figure 42 Self Test Menu



Figure 43 Self Test Version



Figure 44 Self Test Result

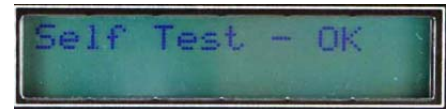

Figure 45 Self Test - Bit Status



## 6 Powerlyzer Features

Parameter Measurement	Range	Resolution
Voltage	0 to 550 VAC	+/- 0.2%
Current	0 to 9999 Amps	+/- 0.5%
Blink Voltage	0 to 108 VAC	+/- 2.0%
Blink Duration	½ to 4 Sec	½ Cycle
Power Loss	4 Sec or Greater	1 Second
Blink / Power Loss Storage	200 Events	
Phase Angle	0 to 359.5°	+/- 0.5°
KW	-9999 to +9999 kW	+/- 0.5%
KVAr	-9999 to +9999 kVAr	+/- 0.5%
KVA	0 to 9999 kVA	+/- 0.5%
Power Factor	- 0.5% to +0.5%	+/- 0.5%
Line Frequency	50Hz or 60Hz	+/- 0.02 Hz
Phase Rotation	ABC or ACB	
Harmonics	1 <sup>st</sup> through 37 <sup>th</sup>	

## 7 Recording Parameters

Trend Parameters	Voltage, Current, Phase Angle
Derived Parameters	KW, kVAr, kVA, Power Factor
Number of Measured Phases	1, 2, or 3
Trend Period (Minutes)	15, 5, 2, 1
Max Records	65536
Blink / Power Loss Storage	200 Events
Min-Max Voltage Storage	4 Second and 1 Minute

## 8 Environmental Specifications

Condition	Range
Operating Temperature	-40°F to 165°F
Humidity (Non-Condensing)	0 to 100%
Operating Voltage	95 to 530 VAC
Input Measurement Current Range	0 to 1000 mA/A
Input Measurement Current Range	0 to 3000 mV/A
Power Usage	½ Watt
Enclosure	Nema 4



## 9 Recommended & Optional Accessories

Utilizing Standard device connections, the versatility of the PowerLyzer is unmatched and compatible with various voltage clamps and styles as well as current transformers. The following is a list of commonly recommended accessories.



**NOTE**  
 To: Operator  
 From: Valquest

*The Powerlyzer is supplied in both a voltage input configuration and a current input configuration. Check your configuration prior to connecting any new devices for compatibility. Failure to provide the proper voltage/current input type may result in damage to the equipment and create an unsafe electrical condition. Failure to set the correct input range and input ratio may also damage unit.*

### 9.1 AC Current Transformers/Probes (Current Output)

Standard Powerlyzer (Current Model)				
Mfr.	Model #	AC Range	DC Range	Output Signal
Flex-Core	MN106	150A	-	1mA/A
Flex-Core	MN213	200A	-	1mA/A
Flex-Core	MD303	500A	-	1mA/A
Flex-Core	SR604	1000A	-	1mA/A
Flex-Core	JM800A	1000A	-	1mA/A





### 9.2 AC Current Transformers/Probes (Voltage Output)

<b>Standard Powerlyzer (Voltage Model)</b>				
<b>Mfr.</b>	<b>Model #</b>	<b>AC Range</b>	<b>DC Range</b>	<b>Output Signal</b>
Flex-Core	MR411	40A 400A	60A 600A	10mV/A 1mV/A
Flex-Core	MR521	100A 1000A	150A 1500A	10mV/A 1mV/A
Flex-Core	SR661	20A Peak 200A Peak 2000A Peak	- - -	100mV/A 10mV/A 1mV/A
Fluke	i200	1A 200A	- -	100mV/A 10mV/A
Fluke	i400	40A 400A	-	10mV/A 1mV/A
Fluke	I3000	30A 300A 3000A	-	100mV/A 10mV/A 1mV/A
Flex-Core	LEM-Flex RR3035-24 RR3035-36 RR3035-48	30A 300A 3000A	- - -	100mV/A 10mV/A 1mV/A



## 9.3 Mounting Accessories (*Optional*)

(*Optional*) mounting brackets are available for the Powerlyzer. These brackets allow the powerlyzer to be installed safely in areas where it is impractical or unsafe to leave the powerlyzer in a stand-alone or “just sitting there” condition.

### 9.1.1 Pole/Structure Mounting Kit

The Pole Mounting Kit consists of a Single Sturdy Brushed Aluminum Plate and hardware which will allow the plate to be fastened to the back of the Powerlyzer. The Bracket extends beyond the Powerlyzer on each end allowing for connection to a Pole or other suitable structure using Lag bolts or similar fastening devices. The Plate can be mounted on the Powerlyzer in both a vertical position or a horizontal position.



Figure 46 Pole Mounting Kit



Figure 47 Powerlyzer w/ Pole Mounting Plate



### 9.1.2 Magnetic Mounting Kit

The Magnetic Mounting Kit consists of a set of (4) powerful magnetic fasteners and hardware. The magnets are fastened to the back of the Powerlyzer in each corner. This arrangement provides an optimal solution where there are adequate metal surfaces and/or equipment or facilities to place the Powerlyzer in a safe operating mode.

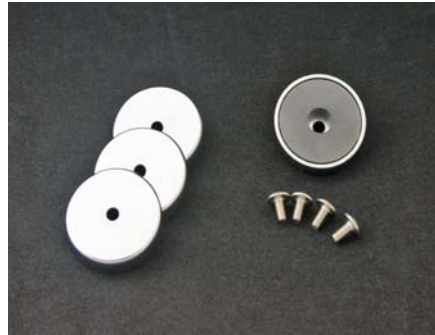

Figure 48 Magnetic Mounting Kit

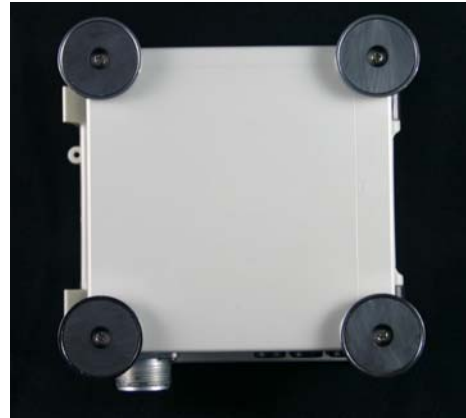

Figure 49 Powerlyzer w/ Magnetic Mounting Kit

### 9.1.3 Wall Mounting Kit

The Wall Mounting Kit consists of a set of (4) small steel Wall Mounting brackets and hardware. Fasten the steel brackets to the back of the Powerlyzer in any or all corners. This arrangement provides an optimal solution where a magnetic mount or pole mount arrangement is not practical and limited facilities exist. Connection to the facility may be made via any number of methods based upon what is available or practical for the situation (ie. Tie Wraps/Nails/Screws/etc.)



Figure 50 Wall Mounting Kit



Figure 51 Powerlyzer w/ Wall Mounting Kit



## 10 About Valquest Systems

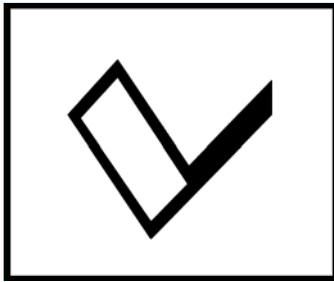

# Valquest Systems What Sets Us Apart

We *Stand* for building strong Client relationships and providing exceptional service and products.

Our *Vision* is to be a leading provider of monitoring and control equipment to small electric utilities on a national basis.

Our *Purpose* is to improve the efficiency of electricity transmission and distribution in America.

Our *Commitment* is to create optimal long-term approaches for our Clients needs.

### **Valquest Systems, Inc.**

351 S. Sherman Street, Suite 100

Richardson, TX 75081

Voice: 972-234-2954

Fax: 972-238-9501

E-Mail: [info@valquest.com](mailto:info@valquest.com)

Website: [www.valquest.com](http://www.valquest.com)